



Extra Ordinary Solutions



EOS
ExtraOrdinary Solutions





Dear Friend,

I'm a lucky man.
Life has given me so much, and I
keep being blessed every single
day! I live in a wonderful place
and I would love to welcome all
of you in my house, one day!

I'm lucky, because I love my job,
and it allows me to remain an
eternal child.
What a huge pleasure for me
to see someone, and kids in
particular, having fun on my
rides!

My Inspiration have led the
company to close important
relationships whit the most
prestigious universities.
Multi-awarded innovative
concept rides have been
developed. You all know them,
and some others are today on
the blueprint.

Our R&D department works with
passion and curiosity, combining
tradition and innovative
tecnologies.

Remember: intuition makes the
difference!

Rigorous quality controls are
carried out in the company on
all the components we buy
and, clearly, on all the finished
products.

A Simple motto stands clear in
every corner of my Workshop:

*"A brand is a signature, a
signature is a commitment".*

And I'm so confident in my
products and in my work, that
I'm ready to commit myself and
put my signature on it!

Owner and CEO,
Loris Darsiè

Index

EXTRAORDINARY SOLUTIONS	007		
the giant ape adventure	011		
EOS FOR CHILDREN	013		
leonardo	015		
volare	017		
funny swing	019		
mini drop tower	021		
convoy	023		
flying chairs	025		
EOS FOR FAMILY	027		
graffiti	029		
double graffiti	031		
torricelli	033		
mini fireball	035		
firefighters	037		
mini ferris wheel	039		
carousel	041		
bumper cars	043		
fun house	045		
walk through	047		
THRILL RIDES	049		
mini challenger	051		
mind blaster	053		
onda	055		
stragadà	057		
galileo	059		
delta	061		
MAJOR RIDES	063		
apollo	065		
drop tower	067		
mind blaster 40	069		
sky swinger	071		
discovery	073		
flume ride	075		
rapid river	077		
ferris wheel	079		
ROLLER COASTERS	081		
Spinning coasters			
wild twister	083		
crazy twister	085		
super twister	087		
mega twister	089		
tt twister	091		
Gravity coasters			
mini tornado with loop	093		
tornado	095		
double loop	097		
mark 300	099		
cheetah coaster	101		
Electric coasters			
columbus	103		
monorail	105		
suspended coaster	107		
DARK RIDES	109		
interactive	113		
safari	115		
horror	117		
educational	119		
video mapping	121		
PARKS	123		
outdoor	127		
indoor	129		
COMPANY & SERVICES	131		



Extra
Ordinary
Solutions

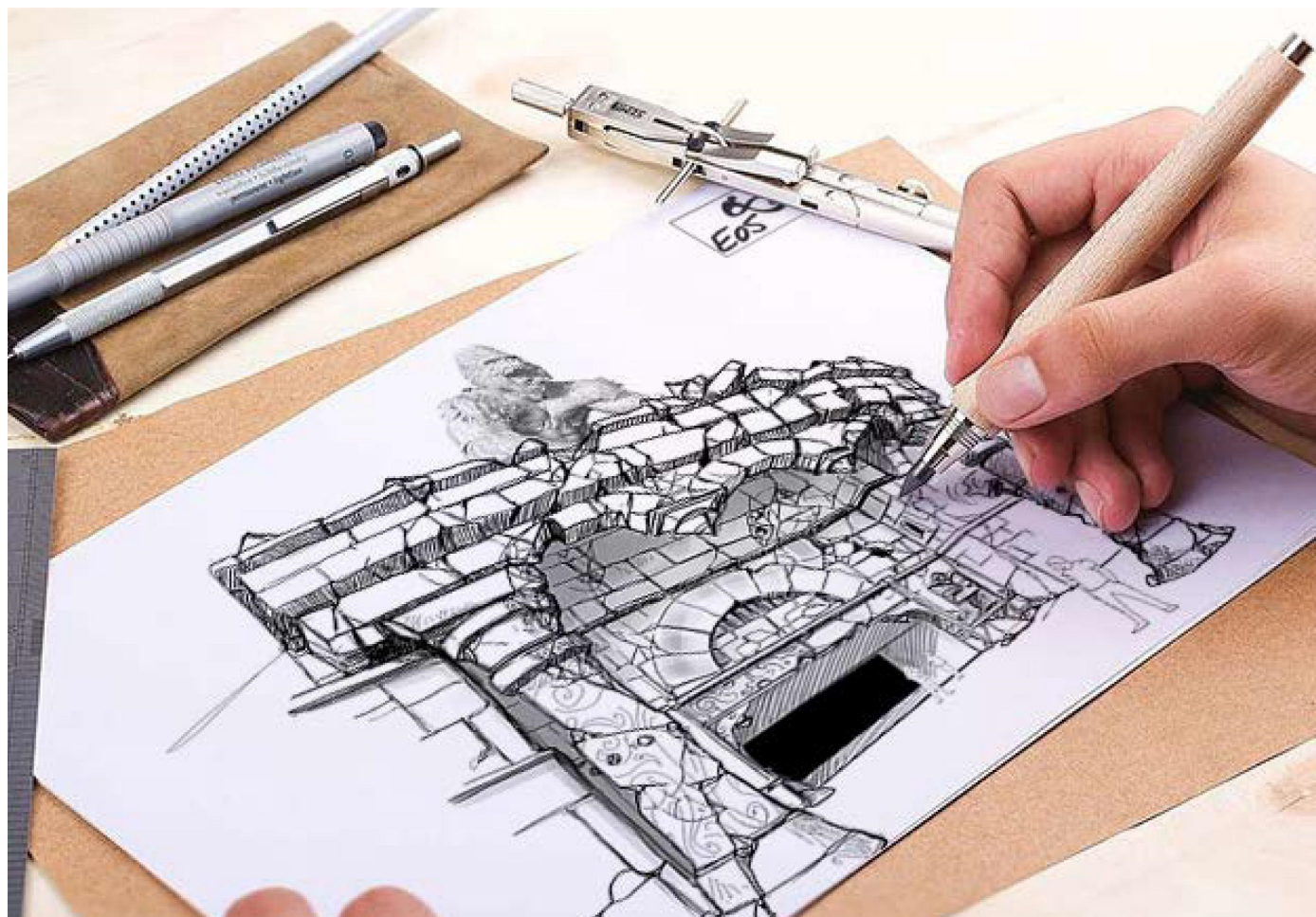

Concept

Over the years, EOS has gained a wide experience in the business of leisure and entertainment, and developed many innovative products and services for the market.

Today we are the sole supplier who can offer you unique and customized solutions, born out of the combination of highly qualified competences and professional expertise.

Creative ideas which put together different technologies, innovative contents, fascinating visions, to offer you and your visitors absolutely unique and unforgettable experiences.

A major ride can become a landmark when installed in an unusual location.



The Giant Ape Adventure

THE GIANT APE ADVENTURE, a whole adventure set, featuring a Customized spinning coaster, an immersive Dark ride experience, and the World BIGGEST Animatronic. The whole set is installed on top of an existing building, in Tunisia, Hammamet City, CarthageLand Theme Park.

The coaster, 280 m long, and reaching a maximum linear speed of 60 km/h, features a train of 5 spinning cars, and the track develops on top of the building, and all around the Giant Ape animatronic.

The Giant Ape figure was designed and carved based on studies of natural science and animals documentary films, to reach a very realistic effect. It is the biggest animatronic ever built, reaching a total height of 13 m! The ape rises its back to its full extensions, rises its arms and punches its breast in anger, while its head turns, the mouth opens with fierce roars, and smokes from its nostrils. After the crazy run and the close approach with the roaring ape, the train enters a closed area, where visitors are taken into a mysterious jungle, meet the hostile inhabitants and the perils of the jungle (a dark ride experience featuring real 3D scenery, projections and video mapping content).



EOS For Children



Brass Ring Award
IAAPA 2012
Best New Product



Leonardo

Prized with the BEST NEW PRODUCT AWARD 2012, LEONARDO is an innovative ride for kids and family produced exclusively by EOS. Here 3 movements combine:

- 1) the dragons move in circle;
- 2) they find an obstacle on the way and jump;
- 3) the gondola swings left and right. In the interactive model kids can play with special music effects and have the dragons smoke from their nostrils.

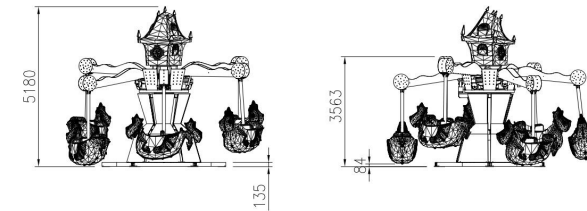

Technical Details 5 arms

Dimensions (m)	Diam. 9 X H 5,2
Seats	5 gondolas, 4 seats each
Capacity	20
Hourly Capacity	500 p/h
Power	7 kW
Shipment Requirements	1x40' BOX

Technical Details 6 arms

Dimensions (m)	Diam. 11 X H 5,2
Seats	6 gondolas, 4 seats each
Capacity	24
Hourly Capacity	600 p/h
Power	10 kW
Shipment Requirements	1x40' BOX



Volare

Two movements combined in a unique association. In a structure which reminds to a kiddie tower, an arm with two rows of seats moves up and down the column, while swinging. A flight experience for kids 3-12.

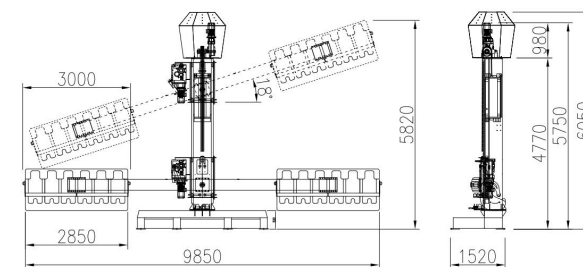

Technical Details

Dimensions (m)	L 11 x W 4 x H 6
Seats	2 rows, 6 seats each
Capacity	12 (4 seats suitable also for adults)
Hourly Capacity	about 500 p/h
Power	12 kW
Shipment Requirements	1x40' OT

Funny Swing

Get on board and start swinging!
 Jump on your seat and enjoy one of the most beloved ride of all times! An amazing compact evergreen ride with a good 12 seats capacity to be placed in FECs or other small areas!

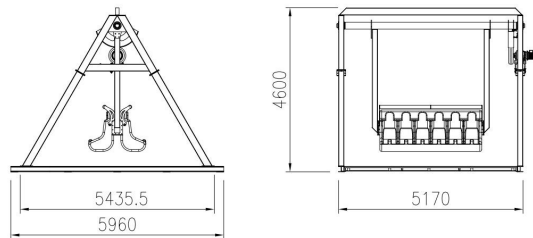

Technical Details

Dimensions (m)	L 7,5m x W 5,6 x H 5,5 m
Seats	2 rows, 6 seats each
Capacity	12 people (adults and kids)
Hourly Capacity	about 400 p/h
Power	7 kW
Shipment Requirements	1x40' OT

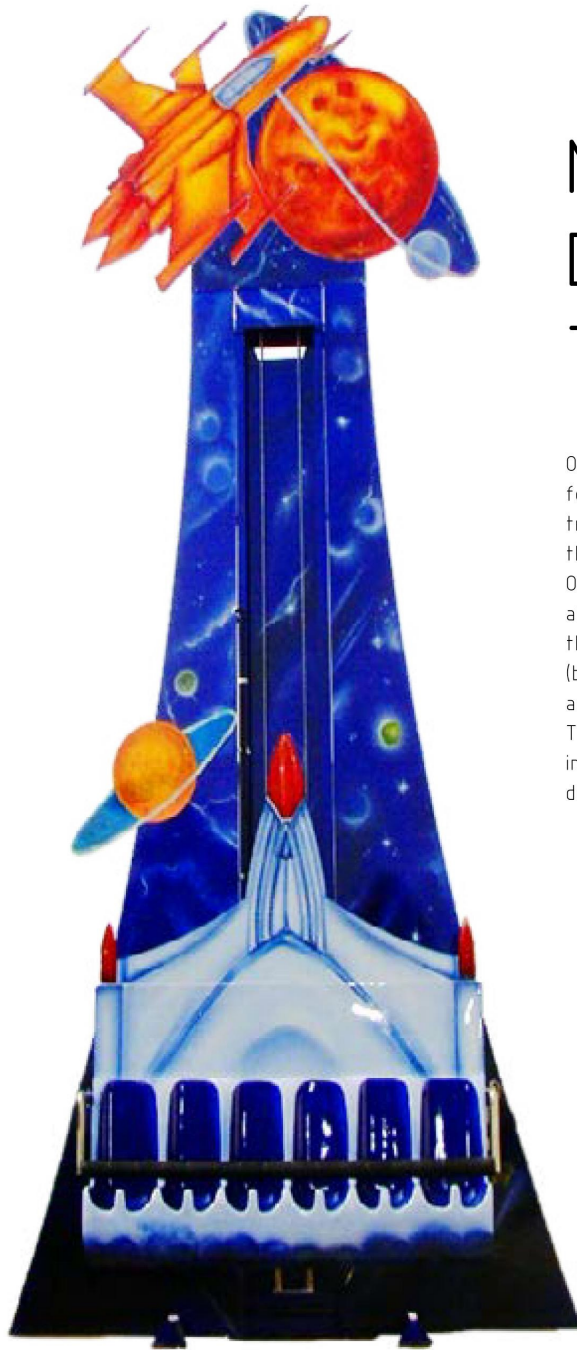

Mini Drop Towers

One of the evergreen rides for any park and FEC, a traditional key of success for the leisure of our children. Out of the 6 seats, 2 seats allow Mum & Dad to ride with their kids. The ride is pneumatic (by air), performing a very wide and smooth movement. The Mini Drop Tower is available in different themes, customized decoration and customized size.

Technical Details 6 metres

Dimensions (m)	L 3,5 X W 4 X H 6
Drop (m)	4
Capacity	6 kids (or 2 adults and 4 kids)
Hourly Capacity	about 240 p/h
Power	13 kW
Shipment Requirements	1x20' BOX

Technical Details 8 metres

Dimensions (m)	L 3,5 X W 4 X H 8
Drop (m)	4
Capacity	6 kids (or 2 adults and 4 kids)
Hourly Capacity	about 240 p/h
Power	13 kW
Shipment Requirements	1x40' BOX

Technical Details 10 metres

Dimensions (m)	L 4,7 X W 6,2 X H 10
Drop (m)	6
Capacity	6 kids (or 2 adults and 4 kids)
Hourly Capacity	about 240 p/h
Power	17 kW
Shipment Requirements	1x40' BOX

Technical Details 12 metres

Dimensions (m)	L 5,7 X W 6,2 X H 12
Drop (m)	8
Capacity	6 kids (or 2 adults and 4 kids)
Hourly Capacity	about 240 p/h
Power	17 kW
Shipment Requirements	1x40' BOX

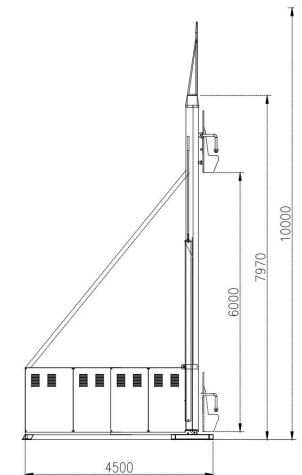



Convoy

My little drivers, get on board and let's take off for the next truck ride! The evergreen truck driving experience for our little children!

Technical Details

Dimensions (m)	L 9 x W 5 x H 3
Trucks	5
Seats	4 seats each truck
Capacity	20
Hourly Capacity	about 480 p/h
Power	8 kW
Speed	adjustable
Shipment Requirements	1x40' BOX

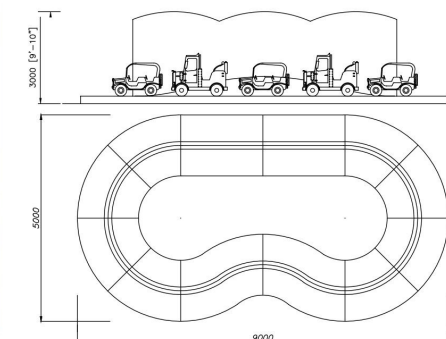



Flying chairs

Enjoy the flight on this evergreen ride for all kids!

Technical Details

Dimensions (m)	diam. 9 x H 4
Seats	20
Hourly Capacity	about 400 p/h
Power	0,75 kW
Rotation Speed	10 RPM
Shipment Requirements	1x20' BOX

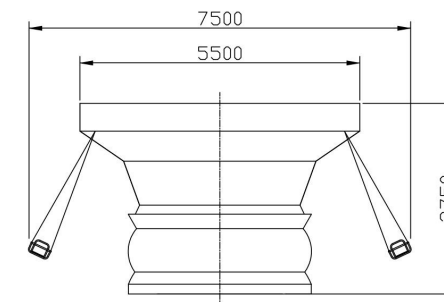



EOS
For
Family

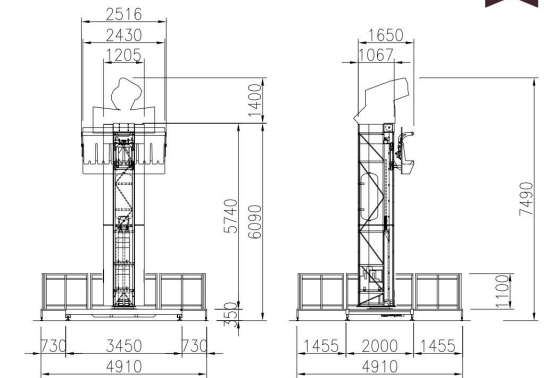

Technical Details 8 metres

Dimensions (m)	L 5,2 X W 5,2 X H 8
Drop (m)	4
Capacity	6 kids (or 2 adults and 4 kids)
Hourly Capacity	about 240 p/h
Power	9 kW
Shipment Requirements	1x40' BOX

Technical Details 10 metres

Dimensions (m)	L 5,2 X W 5,2 X H 10
Drop (m)	6
Capacity	6 passengers
Hourly Capacity	about 240 p/h
Power	12,5 kW
Shipment Requirements	1x40' BOX

Technical Details 12 metres

Dimensions (m)	L 5,2 X W 5,2 X H 12
Drop (m)	8
Capacity	6 passengers
Hourly Capacity	about 240 p/h
Power	18 kW
Shipment Requirements	1x40' BOX

Graffiti

Graffiti is a new concept ride. It combines the traditional movement of the drop tower, with the seats jumping and dropping, with the rotation, clockwise and counter-clockwise of the whole tower itself! The lift/free fall movement is pneumatic, done by using air compressors. This makes the movements very smooth, fluent and wide. The ride is set with different programs controlling the speed of rotation.



Double Graffiti

The popular Graffiti tower, here with 2 rows of seats that move up and down independently.

A real amazing eye-catching effect, and a double capacity within a very small area.

Technical Details 8 metres

Dimensions (m)	L 6 X W 6 X H 8
Drop (m)	4
Capacity	12 kids (or 4 adults and 8 kids)
Hourly Capacity	about 480 p/h
Power	17 kW
Shipment Requirements	1x40' OT

Technical Details 10 metres

Dimensions (m)	L 6 X W 6 X H 10
Drop (m)	6
Capacity	12 passengers
Hourly Capacity	about 480 p/h
Power	26,5 kW
Shipment Requirements	1x40' OT

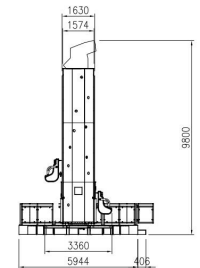

Technical Details 12 metres

Dimensions (m)	L 6 X W 6 X H 12
Drop (m)	8
Capacity	12 passengers
Hourly Capacity	about 480 p/h
Power	35,5 kW
Shipment Requirements	1x40' OT

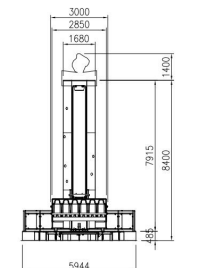



Torricelli

Our Torricelli combines the traditional movement of jumping and dropping, with the rotation, clockwise and counter-clockwise of the whole tower.

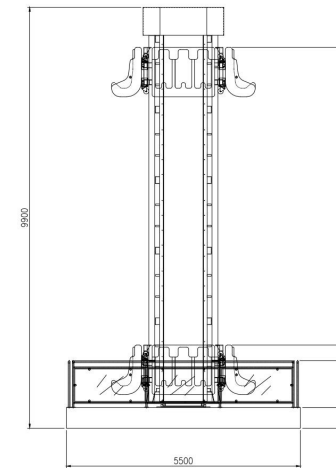

Technical Details

Dimensions (m)	diam 5,5 x H10
Drop (m)	7
Capacity	12 people
Hourly Capacity	about 480 p/h
Power	37
Shipment Requirements	1x40' OT + 1x20' BOX

Mini Fireball

MINI FIREBALL combines the swinging movement with the spinning movement of the seats. The ride is set with 3 different programs controlling the speed of rotation, which makes the ride suitable for the requirements of the different passengers: slower rotation for the small kids, faster for teenagers/adults. The operator simply needs to switch a button on the control panel to select the different program. Easy management for a great family ride!



Technical Details Mini Fireball

Dimensions (m)	L 13 X W 5 X H 4,6
Seats	2 discs, 6 seats each
Capacity	12 kids or adults
Hourly Capacity	about 360 p/h
Power	15 kW
Shipment Requirements	1x40' BOX

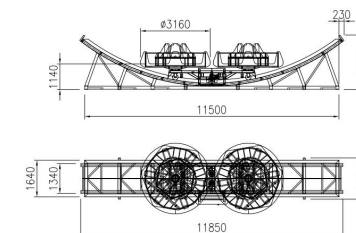

Mini Fireball Plus

Technical Details Mini Fireball Plus

Dimensions (m)	L 16 X W 5 X H 6
Seats	2 discs, 6 seats each
Capacity	12 kids or adults
Hourly Capacity	about 360 p/h
Power	17 kW
Shipment Requirements	1x40' OT

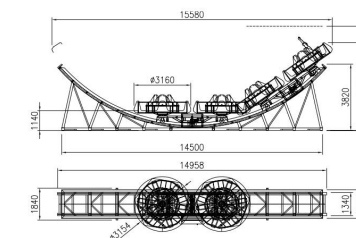

NEW PRODUCT



Firefighters

EOS just developed a new concept of rides based on our Mini Fireball. Instead of the 2 rotating discs, there is a unit shaped completely customizable: a boat, a bus or in this case a fire-brigade old time car.

Kids get their place on board, and the unit swings and rotates, as per the Mini fireball. But each passenger has a different activity!

So the ride becomes interactive , interesting and stimulating.

In the front:

- the driver (on the steering wheel),
- the driver-assistant, who is moving the brake levers,
- the bell ringer, who is ringing the bell to alert

In the back:

- the horn ringer, operated manually with a crank handle
- the steam valve operator, which powered the steam engine moving the vehicle and pumped the water through the hoses. When operated, the valve lets smoke coming out of the boiler pipe.
- The boiler operator, moving the levers controlling the boiler

On both sides of the car, 4 passengers are seating facing outside, and they are provided an individual device resembling water pumps.

NO WATER IS SHOT, but passengers can move their pump in any directions (up/down/left/right), and make a noise when pressing the "shooting" bottom.

Dimensions (m)	L 13 x W 5 x H 4,6
Dimensions (ft)	L 40' x W 17' x H 15'
Capacity	14 passengers
Power	15 kW

The safety area is already included in the dimensions.

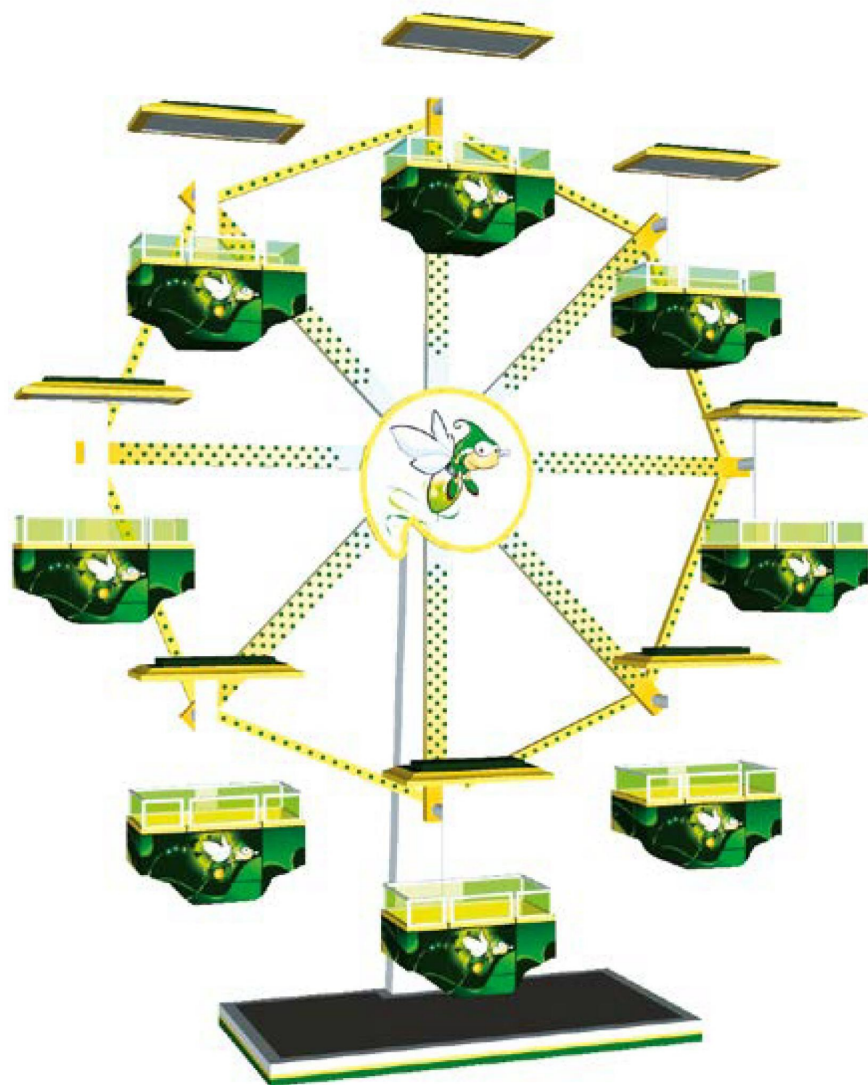

Mini Ferris Wheel

A romantic ride, to get a new perspective on the world. One of the evergreen rides for the family, now in a smaller version, ideal for indoor areas.

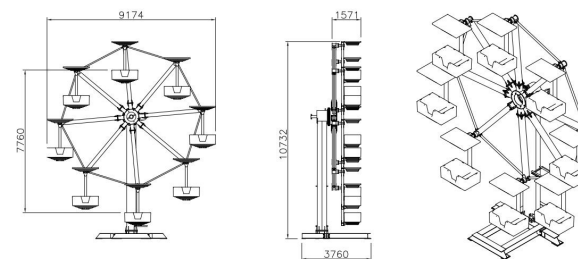

Technical Details

Dimensions (m)	L 9,5 X W 5 X H 11
Cabins	8 gondolas, 4 seats each
Capacity	32 kids or adults
Hourly Capacity	about 720 p/h
Power	12 kW
Shipment Requirements	1x40' OT



Carousel

The most traditional and romantic attraction, always welcomed with joy by kids and adults. Enjoy a fascinating ride, feel like you were living in a fairy tale atmosphere.

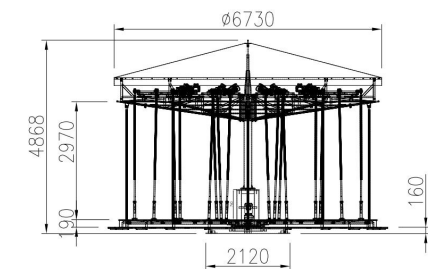

Technical Details

Dimensions (m)	diam. 7 X H 5
Central disk (m)	diam. 7
Capacity	26 kids or adults
Hourly Capacity	about 750 p/h
Power	7 kW
Shipment Requirements	1x40' BOX

Bumper Cars

An evergreen ride for the leisure of kids and adults.

Models

Mini bumper cars	2 kids
Midi bumper cars	1 child and 1 adult
Bumper cars	2 adults

Technical Details

Dimensions (m)	to be designed according to the available area
Vehicles	independent cars
Seats	2 seats each car
Power	0,5 kW / car
Power Systems	Floor pick-up Antennas





● Small rotating barrel

● Aladdin Park



● Sahona facade

Fun House

The Fun house is a funny walk in an area covered with tricks and games. You have to find the way out, walking on trembling floors, crossing hanging obstacles, along magic corridors with moving walls, across complicated mazes, and many other surprising and tricky effects.

It is an highly customizable product, which can be done in any available area. It can also be built as a 2-3-4 floors self-standing building. A ride for the whole family.

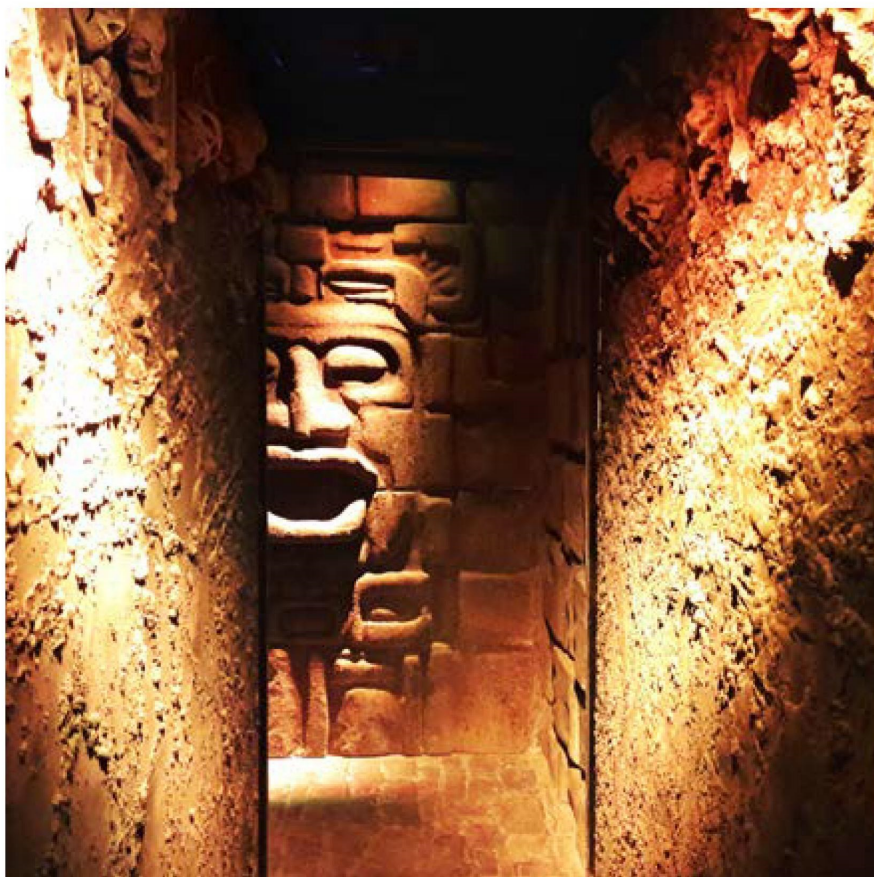

● Maya walk through



● Maya entrance



● Zombie VR effect

Walk through

What about walking inside the deep jungle or in a mysterious ancient temple? EOS walk-through take you into a magic world, where everything is made to amaze you! Grasp the hand of your friends, and walk through the perils of the haunted house, or in the fascinating atmospheres of Aladdin Palace. Between a dark ride and a fun house, EOS walk-through will lead you to an unforgettable adventure!



Thrill Rides



Mini Challenger

The seats rotate in circle, while rising higher and higher in a pendulum giving the sensation of a whirlpool!
One of the most popular and breathtaking rides for the leisure of teens and adults which can provide extraordinary performance both indoor and outdoor!

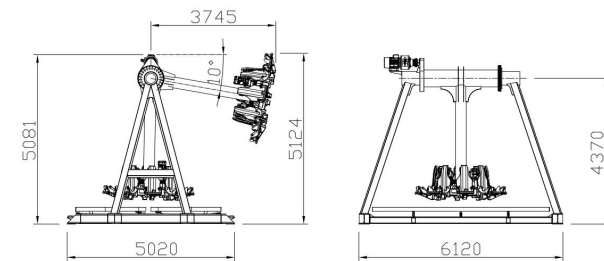

Technical Details 180°

Dimensions (m)	L 8,5 X W 6,2 X H 8,8
Seats	1 disc, 8 seats
Capacity	8
Hourly Capacity	about 280 p/h
Power	25 kW
Shipment Requirements	1x40' OT

Technical Details 360°

Dimensions (m)	L 8,5 X W 6,2 X H 8,5
Seats	1 disc, 8 seats
Capacity	8
Hourly Capacity	about 280 p/h
Power	28 kW
Shipment Requirements	1x40' OT

Mind Blaster

The attraction for those who seek extreme emotions. Two rotating discs swing left and right, up and down and WOOOW! The platform under the discs rises and tilts! Giving you the sensation of being ejected! A really breathtaking experience!!!

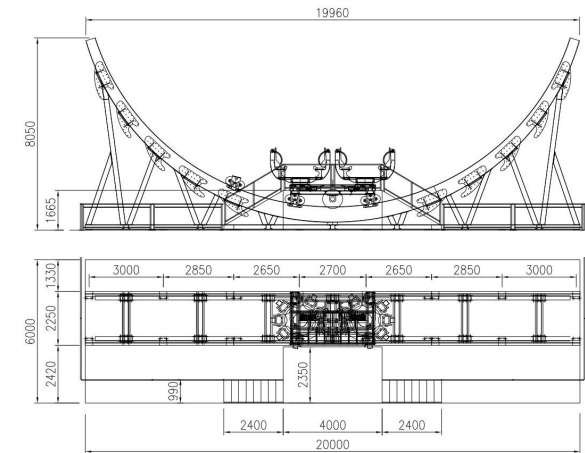

Technical Details Mind Blaster

Dimensions (m)	L 20 X W 6 X H 9,5
Seats	2 discs, 8 seats each
Capacity	16
Hourly Capacity	about 500 p/h
Acceleration	2 G
Power	53 kW
Shipment Requirements	3x40' OT

Technical Details Mind Blaster XXL

Dimensions (m)	L 24 X W 6 X H 12
Seats	2 discs, 12 seats each
Capacity	24
Hourly Capacity	about 750 p/h
Acceleration	2 G
Power	68 kW
Shipment Requirements	5x40' OT

NEW PRODUCT

Onda

A ride with a major impact. 24 riders surfing on a spinning disc, swinging up and down on a long wave. Inspired by our amazing Mind Blaster, the Onda has an extended track with a camelback hump right in the middle. As result we have a new amazing ride that will make you live some new thrilling emotions.

Dimensions (m)	L 80 x W 11 x H 13
Seats	1 disc, 24 seats
Capacity	24 passengers
Hourly Capacity	500 p/h
Power	80 kW



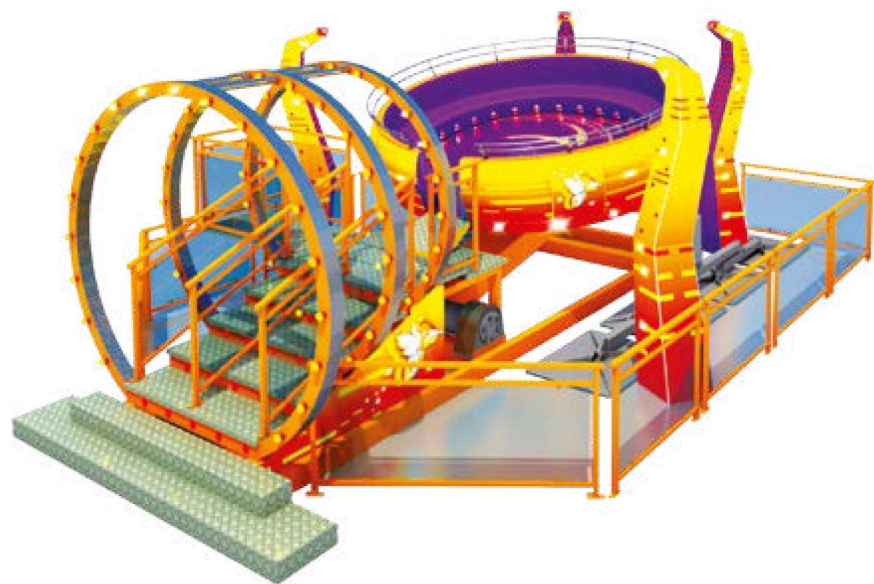

Stragadà

It is a renewed version of a classic ride, now completely automatically controlled by EOS. A must, especially for teens!

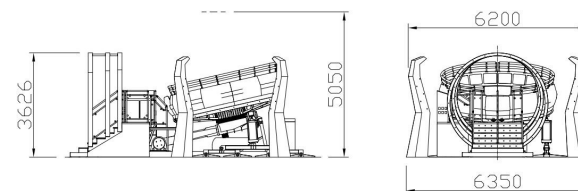

Technical Details

Dimensions (m)	L 10,2 X W 5 X H 4,5
Seats	20
Capacity	20
Hourly Capacity	480 p/h
Special Feature	completely automated
Power	29 kW
Shipment Requirements	1x40' OT



Galileo

Three movements combined in a unique thrilling ride:

- 1) The seats do twist, spinning 360° back and forth;
- 2) The seats are gripped by a "pliers" device, which rotates 360° left and right;
- 3) A main beam is connecting the two gondolas.

The beam is also rotating 360°. It takes you up to the highest point, then down to the ground, in a circular movement. A new patented ride, which will make you lose any sense of direction.

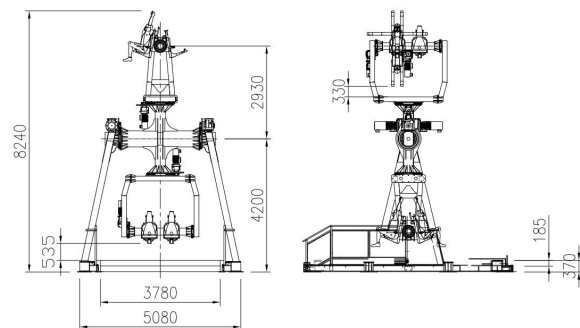

Technical Details

8m 10m 18m

Dimensions (m)	L 7,5 x W 5,7 x H 8,5	L 9 x W 5,7 x H 10	L 17 x W 5,7 x H 18
Seats	2 blocks of 4 seats	2 blocks of 4 seats	2 blocks of 4 seats
Capacity	8	8	8
Hourly Capacity	200 p/h	200 p/h	200 p/h
Power	35 kW	35 kW	78 kW
Shipment Requirements	2x40' OT	2x40' OT	3x40' OT





Delta

Brass Ring Award
IAAPA 2013
Best New Product
NOMINEE



Delta is a thrilling flying experience. You are risen up, in vertical, and then descend, your nose facing down very close to the ground... and up again, but with your head down! Experience the zero gravity effect!

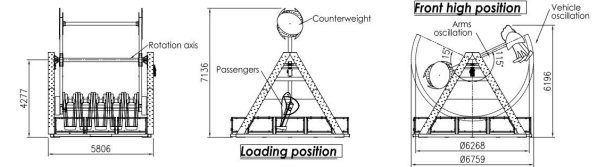

Technical Details

Dimensions (m)	L 7 x W 6 x H 7,5
Seats	5
Capacity	5
Hourly Capacity	240 p/h
Power	14 kW
Max height reached (m)	7,5
Shipment Requirements	1x40' OT



Major Rides



Apollo

The most eye-catching major ride produced by EOS. The patented movement of the seats that turn into an horizontal position before the structure starts moving in circle, rising and descending, gives people the breathtaking experience of a real flight!

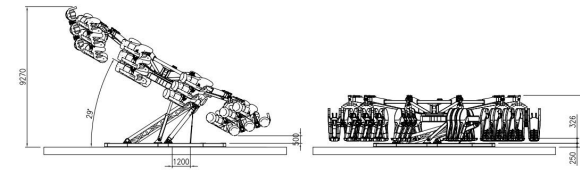

Technical Details

Dimensions (m)	diam. 16 x H 10
Seats	10 arms, 3 seats each
Capacity	30
Hourly Capacity	about 900 p/h
Power	57 kW
Shipment Requirements	5x40' OT



Drop Towers

Rising up towards the sky... And finally released for a free fall drop!!!

This is what a Drop Tower is for! A key of success for the leisure of those seeking a real breathtaking experience. Feel your heart drop with our timeless rides.

Technical Details 35m

Dimensions (m)	L10 X W 10 X H 35
Drop (m)	25
Capacity	12
Hourly Capacity	480 p/h
Power	161 kW

Technical Details 40m

Dimensions (m)	L12 X W 12 X H 40
Drop (m)	30
Capacity	12
Hourly Capacity	480 p/h
Power	336 kW

Technical Details 60m

Dimensions (m)	L12 X W 12 X H 60
Drop (m)	50
Capacity	24
Hourly Capacity	650 p/h
Power	500 kW

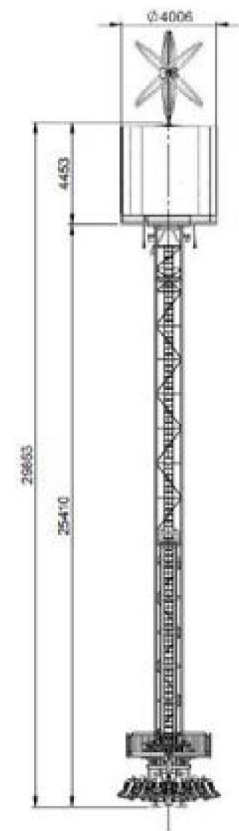

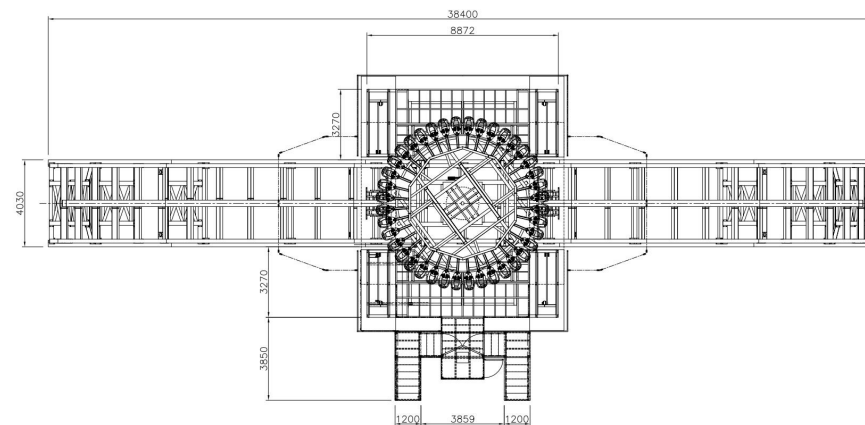

Mind Blaster 40

An really high impact ride!
 One big rotating disc with 40 seats swings up and down on U-shape track. A major size ride, for a major size fun.

Technical Details

Dimensions (m)	L40 X W 15 X H 17
Seats	40
Capacity	40
Hourly Capacity	1200 p/h
Acceleration	2G
Power	65 kW
Shipment Requirements	9x40' OT





Sky Swinger

The most sensational version of the traditional flying chairs. The chairs rise up, 40 m high, and take riders straight up in the sky, and let them fly around and around... what a unique viewpoint on the world!

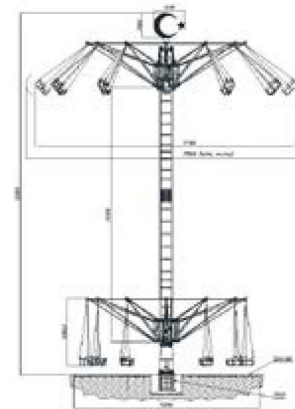

Technical Details

Dimensions (m)	diam. 15 X H 30
Seats	12 arms, 2 seats each
Capacity	24
Hourly Capacity	480 p/h
Power	90 kW
Shipment Requirements	6x40' OT



Discovery

Swing left and right spinning around and around, rising higher and higher. One of the most popular and breathtaking major rides for the leisure of teens and adults.

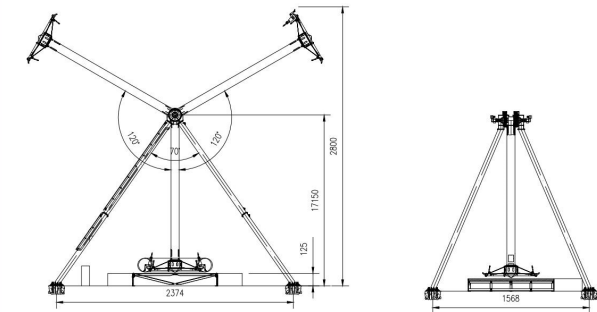

Technical Details

Dimensions (m)	L 24 x W 16 x H 28
Seats	1 disc, 24 seats
Capacity	24 people
Hourly Capacity	about 480 p/h
Power	230 kW
Shipment Requirements	5x40' OT

Flume Ride



Get on board of a wooden log and let the flow lead you along the river in an exciting journey. Feel the thrill of the rapid descent and the splashdown into the pool! EOS proposes a double circuit ride, with a first climb and chute of 6 m, and a second one of 9m. The corridors between the peaks and the descends are featuring water circuits too, for a more realistic sailing experience along the whole track.

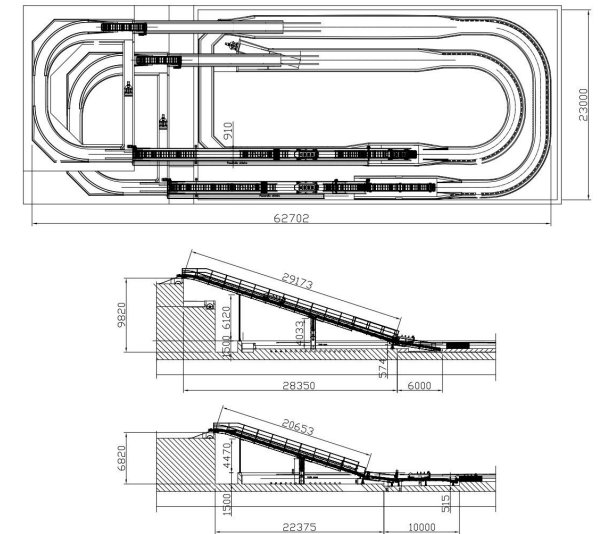

Technical Details

Dimensions (m)	L 63 x W 24 x H 13
Climbs/Chutes (m)	6 and 9
Channel length (m)	270
Boats	8 logs, 4 passengers each
Capacity	32 passengers
Hourly Capacity	1000 p/h
Power	140 kW
Shipment Requirements	5x40' OT



Rapid River

A canyoning adventure, where round boats are taken by the rapids in a wild rush, simply moved by the water stream.
A great ride for the fun of the whole family!

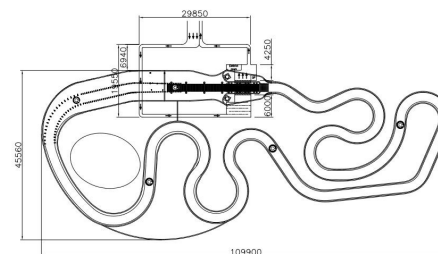

Technical Details

Dimensions (m)	L 110 x W 55 x H 7
Channel length (m)	440
Boats	8 round boats
Capacity	48 passengers
Hourly Capacity	960 p/h
Power	200 kW
Shipment Requirements	5x40' OT

Ferris Wheel

The most famous and beloved ride of all times! The landmark of any amusement park. EOS proposed the 34m wheel, featuring 24 gondolas. A very big size, for a very romantic ride.

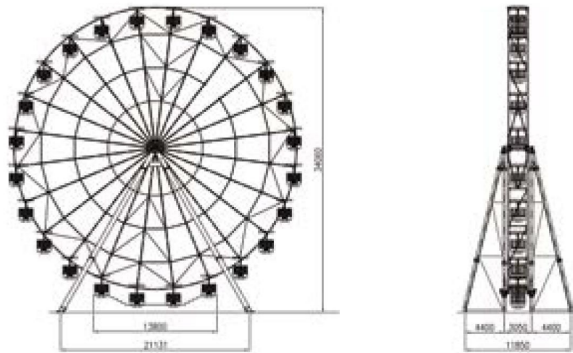

Technical Details

Dimensions (m)	L22 X W 12 X H 34
Cabins	24, 6 seats each
Capacity	144 passengers
Hourly Capacity	675 p/h
Power	78 kW
Shipment Requirements	12x40' OT





Roller Coasters

Spinning Coaster

Wild Twister

The Wild Twister is the smallest spinning coaster in the world! Great fun and surprising effects in a very limited space: only 18 x 12.5 m! A major façade is the landmark for this attraction, perfect for any park.

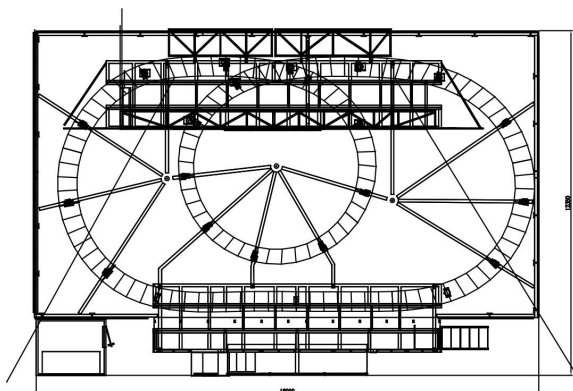

Technical Details

Dimensions (m)	L 18 x W 12,5 x H 6
Track length (m)	70
Train	1 train
Spinning Wagons	4 wagons, 4 seats each
Capacity	16 passengers
Hourly Capacity	400 p/h
Power	54 kW





Spinning Coaster

Crazy Twister

The little jewel of spinning coaster technology! Compact in size, with spinning cars moved by gravity, every time you take a ride you get a different whirl.

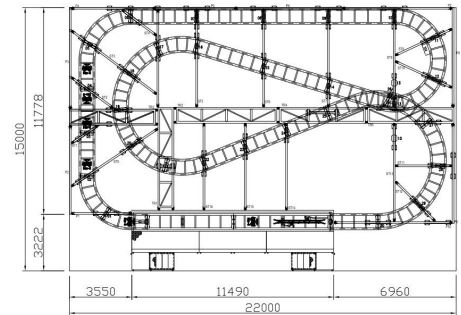

Technical Details

Dimensions (m)	L 22 x W 15 x H 8
Track length (m)	110
Train	1 train
Spinning Wagons	5, 4 seats each
Capacity	20 passengers
Hourly Capacity	about 650 p/h
Power	54 kW



Spinning Coaster

Super Twister

Our medium size Spinning Coaster. Spin along its curves and spirals, and enjoy the fun!

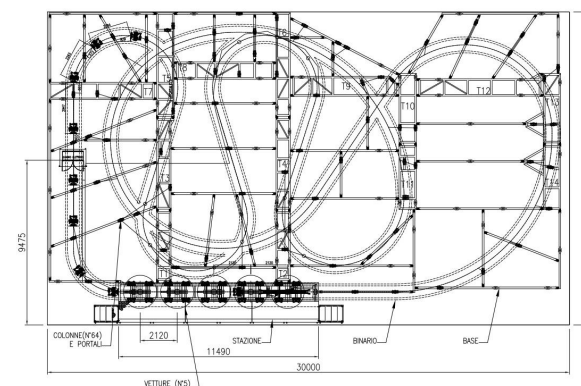

Technical Details

Dimensions (m)	L 30 x W 18 x H 10
Track length (m)	250
Train	1 train
Spinning Wagons	6 wagons, 4 seats each
Capacity	24 passengers
Hourly Capacity	750 p/h
Power	74 kW

Spinning Coaster

Mega Twister

A longer track for a longer fun. The Mega Twister is EOS longest spinning coaster, reaching 250 m track, always in an incredibly compact space.

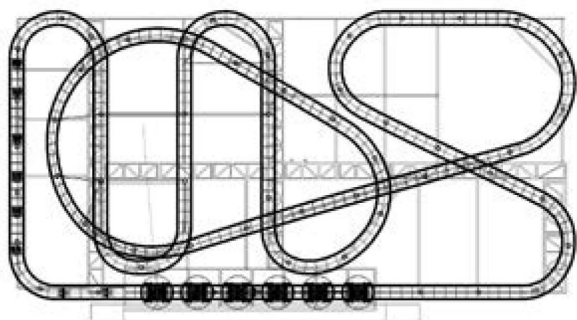

Technical Details

Dimensions (m)	L 35 x W 24 x H 10
Track length (m)	250
Train	1 train
Spinning Wagons	6 wagons, 4 seats each
Capacity	24 passengers
Hourly Capacity	about 750 p/h
Power	95 kW





Spinning Coaster

TT Twister

A great spinning coaster, which can have three more rides installed within its spirals! A smart concept track allowing to exploit the area at the utmost.



Technical Details

Dimensions (m)	L 30 x W 28 x H 10
Track length (m)	180
Train	1 train
Spinning Wagons	5 wagons, 4 seats each
Capacity	20 passengers
Hourly Capacity	about 650 p/h
Power	97 kW

Gravity Coaster

Mini Tornado With Loop

Our best selling small gravity coaster, for the leisure of kids and adults. With its spiral and fast descent, it is a small ride providing great emotions. Perfect for FECs and small parks.

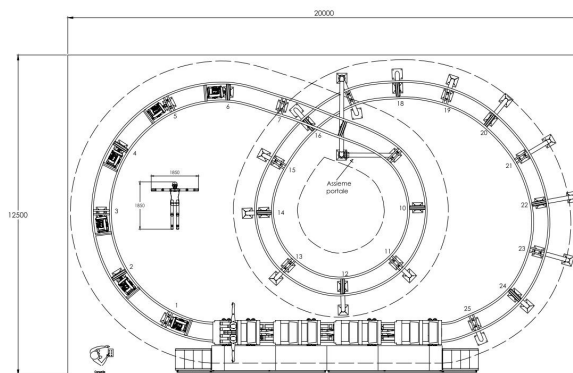

Technical Details

Dimensions (m)	L 20 x W 12,5 x H 6
Track length (m)	65
Train	1 train
Wagons	1x4 pax and 4x2 pax
Capacity	12 passengers
Hourly Capacity	about 400 p/h
Power	34 kW





Gravity Coaster

Tornado

A smart solution to have a long gravity coaster in a pretty small place: leave the station, climb up, then fast down and continue your run ABOVE the station itself. Born for travelling shows, the tornado remains a smart concept ride for any small park.

Technical Details

Dimensions (m)	L 23,5 x W 15 x H 8
Track length (m)	125
Train	1 train
Wagons	5 wagons, 4 seats each
Capacity	20 passengers
Hourly Capacity	about 600 p/h
Power	47 kW

Gravity Coaster

Double Loop

A long track within a small height area. Climb up, then descend, and up again for a new whirl. A Double spiral track, for a double size fun.

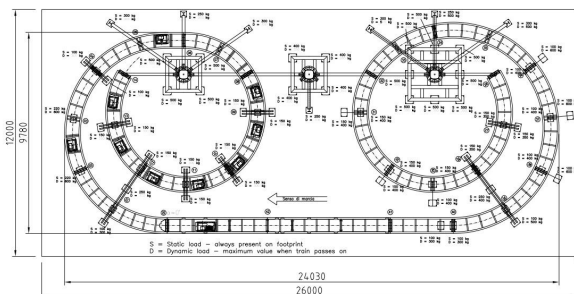

Technical Details

Dimensions (m)	L 26 x W 12 x H 6,5
Track length (m)	105
Train	1 train
Spinning Wagons	5 wagons, 4 seats each
Capacity	20 passengers
Hourly Capacity	about 600 p/h
Power	45 kW





Gravity Coaster

Mark

Original track layouts, in different lengths, to guarantee the highest level of fun in any size.

Technical Details Mark 150

Dimensions (m)	L 32 x W 16 x H 9
Track length (m)	155
Train	1 train
Wagons	5 wagons, 4 seats each
Capacity	20 passengers
Hourly Capacity	about 600 p/h
Power	50 kW

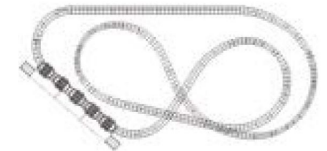

Technical Details Mark 250

Dimensions (m)	L 40 x W 25 x H 12
Track length (m)	250
Train	1 train
Wagons	6 wagons, 4 seats each
Capacity	24 passengers
Hourly Capacity	about 680 p/h
Power	60 kW

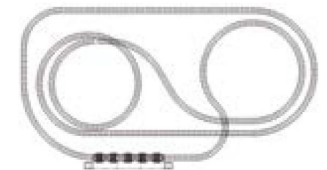

Technical Details Mark 300

Dimensions (m)	L 40 x W 20 x H 14
Track length (m)	300
Train	1 train
Wagons	6 wagons, 4 seats each
Capacity	24 passengers
Hourly Capacity	about 600 p/h
Power	80 kW

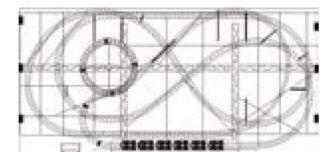

Gravity Coaster

Cheetah

The Cheetah Coaster will surely be the core attraction in any park. The thrilling sensation of a fast run, along surprising curves, spirals, up and down, for an amazing and breathtaking experience for the whole family. Cheetah coaster is the longest family coaster by EOS (600 m long!), featuring the option of two trains and double station.

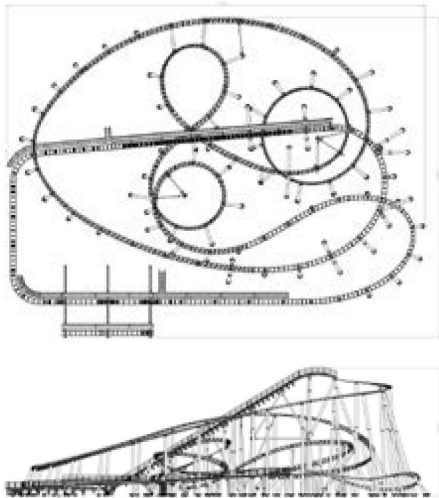

Technical Details

Dimensions (m)	L 77 x W 58 x H 23
Track length (m)	600
Train	2 train
Seats	22 each train
Capacity	44 passengers
Hourly Capacity	about 960 p/h
Power	410 kW



Electric Coaster Columbus

Another innovative ride for children and family leisure. It is an electric coaster built on a opened track (not a close circuit), developed on different heights, where the gondolas move up and down and twist around in some given positions. Dimensions and shapes are customized on the client's side.

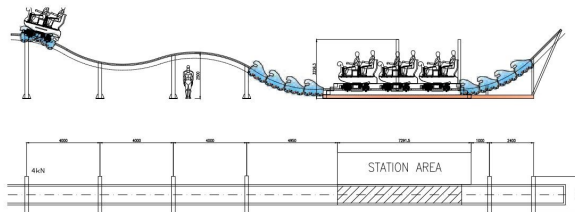

Technical Details

Dimensions (m)	customizable
Vehicles	boat style gondolas moving like a convoy
Seats	4 seats each gondola
Power	12 kW / gondola





● Suspended gondola



● Jurassic model

Electric Coaster

Monorail

A custom track that brings you slowly around, offering a panoramic view on the whole park! Constant speed, even height, for the leisure of the whole family.

Technical Details

Dimensions (m)	to be designed according to the available area
Vehicles	independent gondolas
Seats	4 seats each gondola
Power	3 kW / gondola



Electric Coaster

Suspended Coaster

A customized track, developed on different heights, where the gondolas run suspended.

The gondolas can move up in spiral, and descend, they can change speed, even with sudden accelerations and abrupt stops, thus creating very dreamy experiences, rich in sensation.

Technical Details

Dimensions (m)	to be designed according to the available area
Vehicles	independent gondolas
Seats	4 seats each gondola
Power	3 kW / gondola



Dark Rides

What's a dark ride?

A dark ride is an immersive experience into a different world. Let's go for a safari in a mysterious jungle, or take off on a flying carpet looking for Aladdin magic lamp, let's meet the protagonists of the most beloved fairy tales, or shake hand with Napoleon and Genghis Khan.

Not only a dark or horror content but surely a ride rich in a magical atmosphere.

EOS is the sole supplier able to provide the complete ride, i.e. high-tech transportation system, complete scenes with traditional elements, animatronics, or state-of-the-art virtual reality contents.



Customized Product

Interactive

Guests can enjoy the full emotion of the dark ride, while interacting with the magic world around. Equipped with a gun, a magic wand, or any other similar device, they can play with the surrounding world, gaining scores or activating amazing special effects as reaction. The dark ride experience becomes a challenge, where you can test your skills and challenge your friends.

Customized Product

Safari

Roaring lions, giant elephants, naughty monkeys are among the most beloved creatures for anyone who wants to explore mysterious lands, and the jungle is in fact one of the most popular themes for a dark ride. EOS provides very realistic contents, or cartoon-style environments. 100% customizable contents, which makes every dark ride one of a kind.





Customized Product

Horror

The horror is a classic theme for a dark ride. Besides the traditional animatronics and gloomy sceneries, virtual contents and video-mapping devices can add extraordinary scary effects, for an unforgettable thrilling experience.

Customized Product

Educational

The dark ride is one of the best tools of edutainment. Let's discover the ancient populations, or learn about the way to farm in a remote part of the world, go for math class with Albert Einstein, and listen to Mozart while writing his famous songs. Definitely, a very immersive experience and a different way to teach and learn!



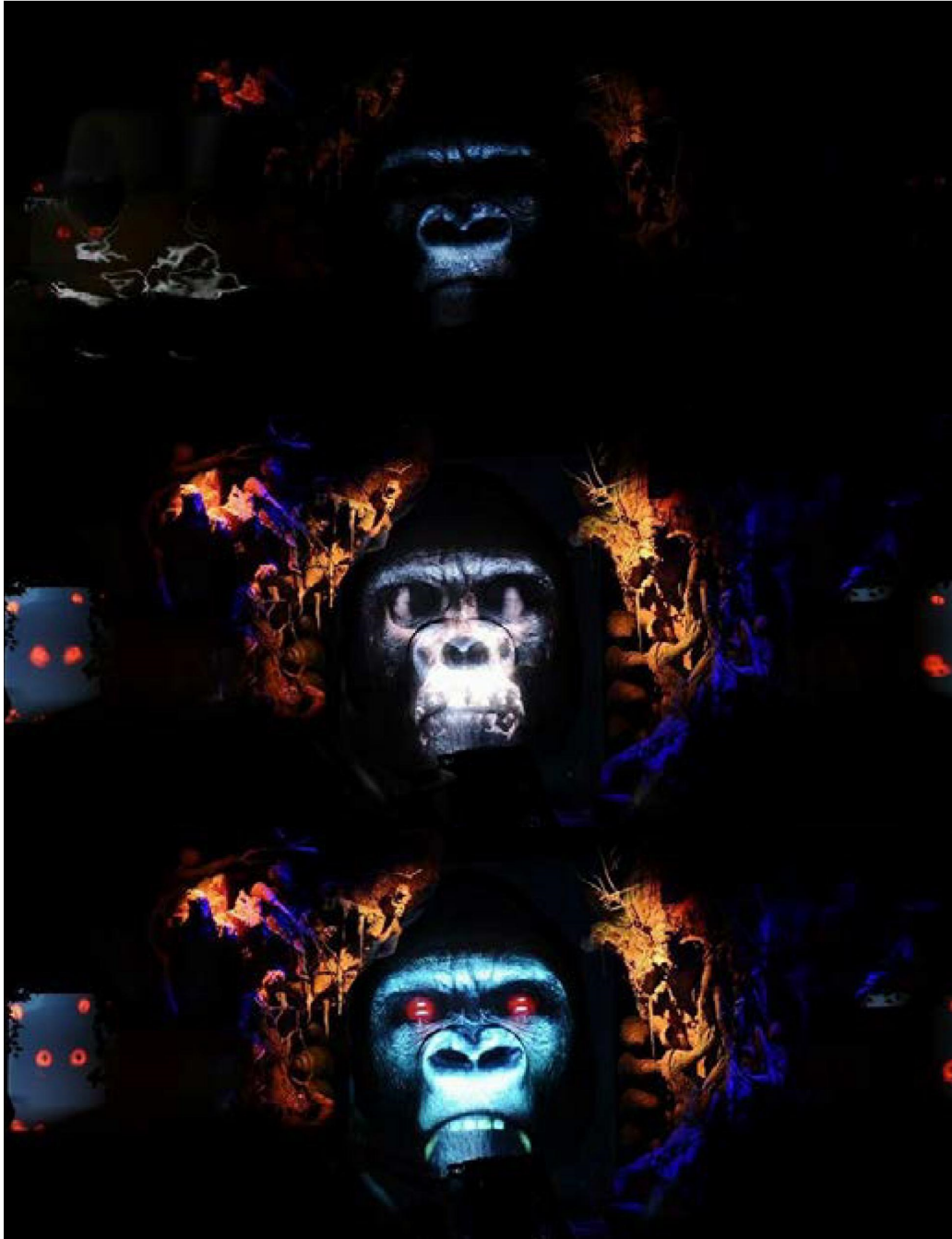

Video Mapping

The state-of-the-art technology of virtual reality applied to a dark ride experience. What used to be seen only at the world's top amusement parks is finally available in smaller scale and for smaller budget, for any park seeking new and high-tech solutions.



Parks

COMPLETE PARKS SOLUTIONS

EOS is the only company who has designed and completely built a number of indoor and outdoor theme parks in different parts of the world. EOS provides turn-key solutions for complete parks, and assists the client in these projects with a highly professional approach, which goes through the following steps:

1/ Market Analysis

Identifying the potential flow of clients, divided by age group and gender, their purchasing power and Per capita Income, their purchase behaviors.

2/ Competitors Analysis

Checking the location of the competitors, the offers and services available on the target market, the range of influence in relation to the distance from the exact location where the new park is to be built.

3/ Creating an Identity

Together with the client, a "theme" is chosen which will identify the new park, making it highly recognizable and unique. All the buildings, the structures, the rides, and every single element of the park will be coherent with the chosen theme, working in harmony to create the clear concept of a unique and different world. Identity also refers to the name of the park, its logo, its mascot, the uniforms, the merchandise and everything which combines and integrates to create a highly different experience.

4/ Business Plan

Based on the data of the market, a business plan is studied in details, analyzing all the different costs (investments, infrastructures, logistics, staff, marketing...), the expected revenue performances, the time to reach the break-even point. Among the other services, EOS can help the client in getting financial facilities, proven the financial solidity of the client.

5/ Start Up

Besides the supply of rides, EOS can help the clients in all the civil works, decoration, sub-structures, and everything needed to open a new park. EOS helps the client in the selection and training of a staff, who will run and manage the park, and assists the client in the whole start-up.

Besides the services mentioned above, in some cases EOS is available to discuss the option of investing in the project, thus becoming a financial partner and stakeholder.



Outdoor



MAZAKALAND Theme Park, Kayseri, Turkey.

Mazakaland is the sole privately managed area within a wider project by Kayseri Town Municipality. The whole project called "Anatolia Heritage World" covers a total area of 465.000 sq. m. and features different facilities.

Elit, EOS's partner, won the Tender to built and manage the amusement park.

Completely supplied by EOS, from the design to the turn-key supply, Mazakaland consists in 80.000 sq.m. of outdoor park (plus a 10.000 sq.m. of indoor area) is divided into four themed areas: Africa, Far East, Ancient Rome and Anatolia.

All the rides, bars and restaurants, gardens, lighting, urban facilities are designed and decorated according to the different theme areas where they are fixed.

More than that EOS studied the brand name, logo and mascot of the theme park inspired to the heritage of the Mazaka people, the local tribe who use to live in Kayseri.

Indoor

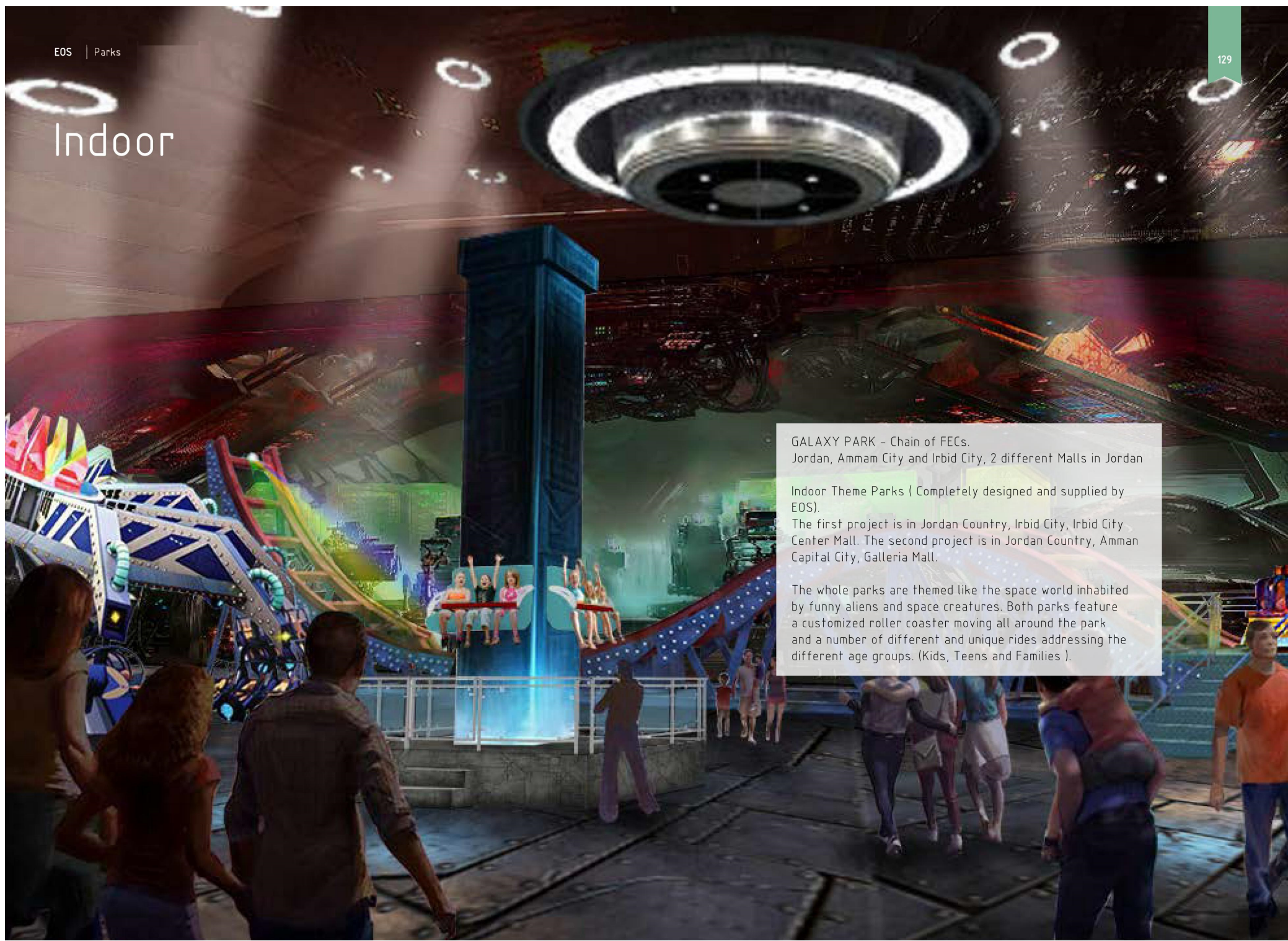

GALAXY PARK - Chain of FECs.
Jordan, Amman City and Irbid City, 2 different Malls in Jordan

Indoor Theme Parks (Completely designed and supplied by EOS).
The first project is in Jordan Country, Irbid City, Irbid City Center Mall. The second project is in Jordan Country, Amman Capital City, Galleria Mall.

The whole parks are themed like the space world inhabited by funny aliens and space creatures. Both parks feature a customized roller coaster moving all around the park and a number of different and unique rides addressing the different age groups. (Kids, Teens and Families).

Company and Services

100% ITALIANO

All the production phases are done within our factory, in Treviso (Italy).

SERIOUS IN MAKING FUN

With almost 20 years of experience, we are reliable partners for your business.

TAILOR-MADE SOLUTIONS

Because every customer is unique. Our projects look like you.

PRÊT À SERVIR

Efficiency and promptness in all your requirements and in the after-sales assistance.



THE BEST PARTNER
FOR YOUR SUCCESS

+39 0422883466
info@eosrides.com
www.eosrides.com

Via Sacco 3
31040, Nervesa(Treviso)
ITALY



www.eosrides.com